

## ADDENDUM #1

### BELGRADE CENTRAL SCHOOL – SIDING REPLACEMENT PROJECT

Belgrade, Maine

07 October 2022

---

Please include the following changes:

#### **GENERAL ITEMS:**

1. Drawing revisions have been clouded.

#### **CHANGES TO THE SPECIFICATIONS:**

1. Delete Section 00 01 10, Table of Contents, and Insert the attached revised Section 00 01 10, Table of Contents, which includes the addition of Section 00 73 46.
2. Insert Section 00 73 46, Wage Determination Schedule.
3. Section 00 52 13, Article 8, Item 8.4 – This section contradicts Section 31.1 of the 00 72 13 General Conditions, which allows for Delays and Extension of Time due to “causes beyond the Contractor’s control”. Although we are aware of the risk of COVID19 related costs and delays, these potential risks are as impossible to predict as a flood, fire, etc... We ask that this Item be removed from the Contract Agreement.

**Delete Item 8.4 from Section 00 52 13**

#### **CHANGES TO THE DRAWINGS:**

1. A0.0 – ELEVATION KEY PLAN
2. AR1.1 –REMOVALS ELEVATIONS
3. A1.1 – PROPOSED ELEVATIONS
4. A2.1 – DETAILS
5. A2.2 – DETAILS

#### **CLARIFICATIONS AND QUESTIONS ASKED BY BIDDERS:**

1. Section 01 10 00, 1.9, D – Temporary barricades are indicated to separate the construction area from the Owner and Public areas. Please indicate what is required for this separation (i.e., snow fence, chain link, etc..).

**Cones and danger tape will be sufficient for use at entrances and playground areas adjacent to the work area.**

2. The drawing details depict using a “2-inch Celect J Channel”. The factory representative said that they do not offer such a product. The typical detail is to install the 1x2 blocking around the fenestration opening and then attach a 1x4 Celect PVC trim board to cover the required expansion gap. Please advise.

**The 2-inch Celect J-Channel has been changed to Brickmold/J-Channel 7351.**

**ADDENDUM #1**

**BELGRADE CENTRAL SCHOOL – SIDING REPLACEMENT PROJECT**

Belgrade, Maine

07 October 2022

---

3. Can you please confirm that the Contractor is not required to provide Builder's Risk Insurance for this project? We assume where there is no addition, this would be considered a renovation.

**Confirmed. Builders risk insurance is not required**

**ATTACHMENTS:**

1. Drawings and specifications that are revised by Addendum #1.

**END OF ADDENDUM #1**

**SECTION 00 01 10**

**TABLE OF CONTENTS**

**SECTION 1 – BIDDING INFORMATION AND INSTRUCTIONS**

- 00 11 13 – NOTICE TO CONTRACTORS
- 00 21 13 – INSTRUCTIONS TO BIDDERS

**SECTION 2 – FORMS**

- 00 41 13 – CONTRACTOR BID FORM
- 00 43 13 – CONTRACTOR BID BOND
- 00 52 13 – CONSTRUCTION CONTRACT AGREEMENT
- 00 61 13.13 – CONTRACT PERFORMANCE BOND
- 00 61 13.16 – CONTRACT PAYMENT BOND

**SECTION 3 – CONDITIONS OF THE CONTRACT**

- 00 71 00 – DEFINITIONS
- 00 72 13 – GENERAL CONDITIONS
- 00 73 46 – WAGE DETERMINATION SCHEDULE

**SECTION 4 – CONSTRUCTION SPECIFICATIONS**

**DIVISION 01 – GENERAL REQUIREMENTS**

- 01 10 00 – SUMMARY
- 01 26 00 – CONTRACT MODIFICATION PROCEDURES
- 01 29 00 – PAYMENT PROCEDURES
- 01 31 00 – PROJECT MANAGEMENT AND COORDINATION
- 01 32 00 – CONSTRUCTION PROGRESS DOCUMENTATION
- 01 33 00 – SUBMITTAL PROCEDURES
- 01 40 00 – QUALITY REQUIREMENTS
- 01 42 00 – REFERENCES
- 01 50 00 – TEMPORARY FACILITIES AND CONTROLS
- 01 60 00 – PRODUCT REQUIREMENTS
- 01 73 00 – EXECUTION
- 01 74 19 – CONSTRUCTION WASTE MANAGEMENT AND DISPOSAL
- 01 77 00 – CLOSEOUT PROCEDURES
- 01 78 39 – PROJECT RECORD DOCUMENTS

**DIVISION 02 – EXISTING CONDITIONS**

02 41 00 – DEMOLITION

**DIVISION 06 – WOOD, PLASTICS, AND COMPOSITES**

06 10 00 – ROUGH CARPENTRY

**DIVISION 07 – THERMAL AND MOISTURE PROTECTION**

07 25 00 – WEATHER BARRIERS

07 46 33 – CELLULAR PLASTIC SIDING

07 62 00 – SHEET METAL FLASHING AND TRIM

07 90 05 – JOINT SEALERS

**SECTION 5 – CONSTRUCTION DRAWINGS**

-- – COVER SHEET

A0.0 – ELEVATION KEY PLAN

AR1.1 – REMOVALS ELEVATIONS

A1.1 – PROPOSED ELEVATIONS

A2.1 – DETAILS

A2.2 – DETAILS

**END OF SECTION 00 01 10**

**00 73 46**  
**Wage Determination Schedule**

**PART 1- GENERAL**

**1.1 Related Documents**

- A. Drawings and general provisions of the Contract, including General and Supplementary Conditions and other Division 01 Specifications Sections, apply to this Section.

**1.2 Summary**

- A. This Section includes the wage determination requirements for Contractors as issued by the State of Maine Department of Labor Bureau of Labor Standards or the United States Department of Labor.

**1.3 Requirements**

- A. Conform to the wage determination schedule for this project which is shown on the following page.

**PART 2 - PRODUCTS (not used)**

**PART 3 - EXECUTION (not used)**

**State of Maine  
Department of Labor  
Bureau of Labor Standards  
Augusta, Maine 04333-0045  
Telephone (207) 623-7906**

**Wage Determination - In accordance with 26 MRS §1301 et. seq., this is a determination by the Bureau of Labor Standards, of the fair minimum wage rate to be paid to laborers and workers employed on the below titled project.**

**2022 Fair Minimum Wage Rates  
Building 2 Kennebec County  
(other than 1 or 2 family homes)**

<u>Occupational Title</u>	<u>Minimum Wage</u>	<u>Minimum Benefit</u>	<u>Total</u>
Brickmasons And Blockmasons	\$35.00	\$0.00	\$35.00
Carpenter	\$26.40	\$12.38	\$38.78
Carpet Installers	\$20.50	\$0.72	\$21.22
Cement Masons And Concrete Finisher	\$22.13	\$5.18	\$27.31
Construction And Maintenance Painters	\$18.25	\$1.38	\$19.63
Construction Laborer	\$20.00	\$2.15	\$22.15
Control And Valve Installers And Repairers - Except Mechanical Door	\$26.00	\$5.49	\$31.49
Crane And Tower Operators	\$26.75	\$5.78	\$32.53
Drywall And Ceiling Tile Installers	\$26.89	\$2.28	\$29.17
Earth Drillers - Except Oil And Gas	\$23.25	\$5.53	\$28.78
Electricians	\$30.68	\$6.37	\$37.05
Elevator Installers And Repairers	\$56.69	\$42.31	\$99.00
Excavating And Loading Machine And Dragline Operators	\$25.25	\$0.00	\$25.25
Fence Erectors	\$23.00	\$5.72	\$28.72
Floor Layers - Except Carpet/Wood/Hard Tiles	\$21.75	\$5.19	\$26.94
Glaziers	\$24.00	\$2.22	\$26.22
Hazardous Materials Removal Workers	\$20.00	\$2.77	\$22.77
Heating And Air Conditioning And Refrigeration Mechanics And Installers	\$29.00	\$4.23	\$33.23
Heavy And Tractor - Trailer Truck Drivers	\$21.00	\$1.98	\$22.98
Industrial Machinery Mechanics	\$26.00	\$5.82	\$31.82
Industrial Truck And Tractor Operators	\$24.00	\$5.61	\$29.61
Insulation Workers - Floor Ceiling And Wall	\$26.25	\$3.18	\$29.43
Ironworker - Ornamental	\$25.00	\$3.32	\$28.32
Light Truck Or Delivery Services Drivers	\$20.00	\$2.30	\$22.30
Mobile Heavy Equipment Mechanics - Except Engines	\$28.00	\$4.23	\$32.23
Operating Engineers And Other Equipment Operators	\$25.00	\$2.15	\$27.15
Paving Surfacing And Tamping Equipment Operators	\$33.12	\$0.00	\$33.12
Pipelayers	\$28.00	\$7.20	\$35.20
Plumbers Pipe Fitters And Steamfitters	\$27.00	\$4.65	\$31.65
Reinforcing Iron And Rebar Workers	\$21.00	\$5.69	\$26.69
Roofers	\$20.75	\$1.16	\$21.91
Sheet Metal Workers	\$24.20	\$5.22	\$29.42
Sider	\$18.00	\$2.44	\$20.44
Structural Iron And Steel Workers	\$25.25	\$4.97	\$30.22
Tapers	\$26.75	\$1.41	\$28.16
Telecommunications Equipment Installers And Repairers - Except Line Installers	\$33.25	\$10.78	\$44.03
Tile And Marble Setters	\$25.50	\$5.30	\$30.80

**Welders are classified as the trade to which welding is incidental (e.g. welding structural steel is Structural Iron and Steel Worker)**

**Apprentices – The minimum wage rate for registered apprentices are those set forth in the standards and policies of the Maine State Apprenticeship and Training Council for approved apprenticeship programs.**

**For any other specific trade on this project not listed above, contact the Bureau of Labor Standards for further clarification.**

**Title 26 §1310 requires that a clearly legible statement of all fair minimum wage and benefits rates to be paid the several classes of laborers, workers and mechanics employed on the construction on the public work must be kept posted in a prominent and easily accessible place at the site by each contractor and subcontractor subject to sections 1304 to 1313.**

**Appeal – Any person affected by the determination of these rates may appeal to the Commissioner of Labor by filing a written notice with the Commissioner stating the specific grounds of the objection within ten (10) days from the filing of these rates.**

**A true copy**

**Attest:**                     *Scott R. Cotnoir*                      
**Scott R. Cotnoir**  
**Wage & Hour Director**  
**Bureau of Labor Standards**

**Expiration Date: 12-31-2022**

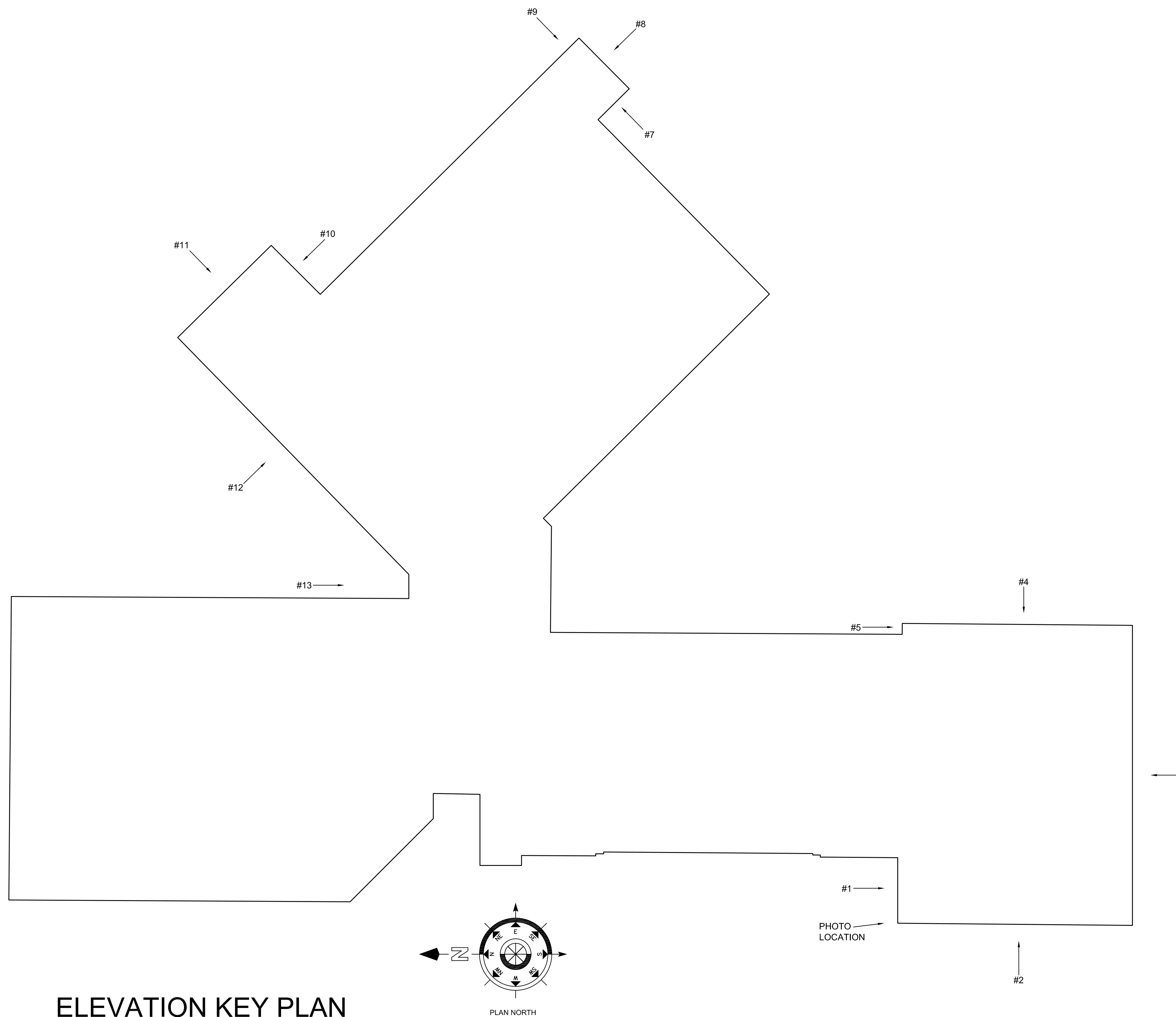

**ELEVATION KEY PLAN**

Project:  
**BELGRADE CENTRAL  
 SCHOOL  
 SIDING REPLACEMENT  
 PROJECT**

Owner:  
**REGIONAL SCHOOL  
 UNIT NO. 18**



Consultant Name and Address:  
 ARCHITECT  
**CHUCK CAMPBELL ARCHITECT PLLC**  
 127 UNION ROAD  
 WALDOBORO, MAINE 04572  
 PHONE: (207) 557-0448  
 E-MAIL: chuck@chuckcampbellarchitect.com  
 WEBSITE: www.chuckcampbellarchitect.com

Firm Name and Address:  
  
**CORDJIA**  
 CAPITAL PROJECTS GROUP  
 Camden, ME | Portland, ME | York, ME  
 207.236.9970 | www.cordjiacapitalprojects.com

Sheet Title:  
**ELEVATION KEY PLAN**

1	ADDENDUM #1	09/30/22
---	-------------	----------

No.	Revision/Issue	Date

Design by:	CMC	Checked by:	MAD
Drawn by:	CMC	Approved by:	MAD

Project:	No. 1401	Date:	JUNE 24, 2022
----------	----------	-------	---------------

Sheet:  
**A0.0**

**BELGRADE CENTRAL SCHOOL  
SIDING REPLACEMENT  
PROJECT**

Owner:  
**REGIONAL SCHOOL  
UNIT NO. 18**

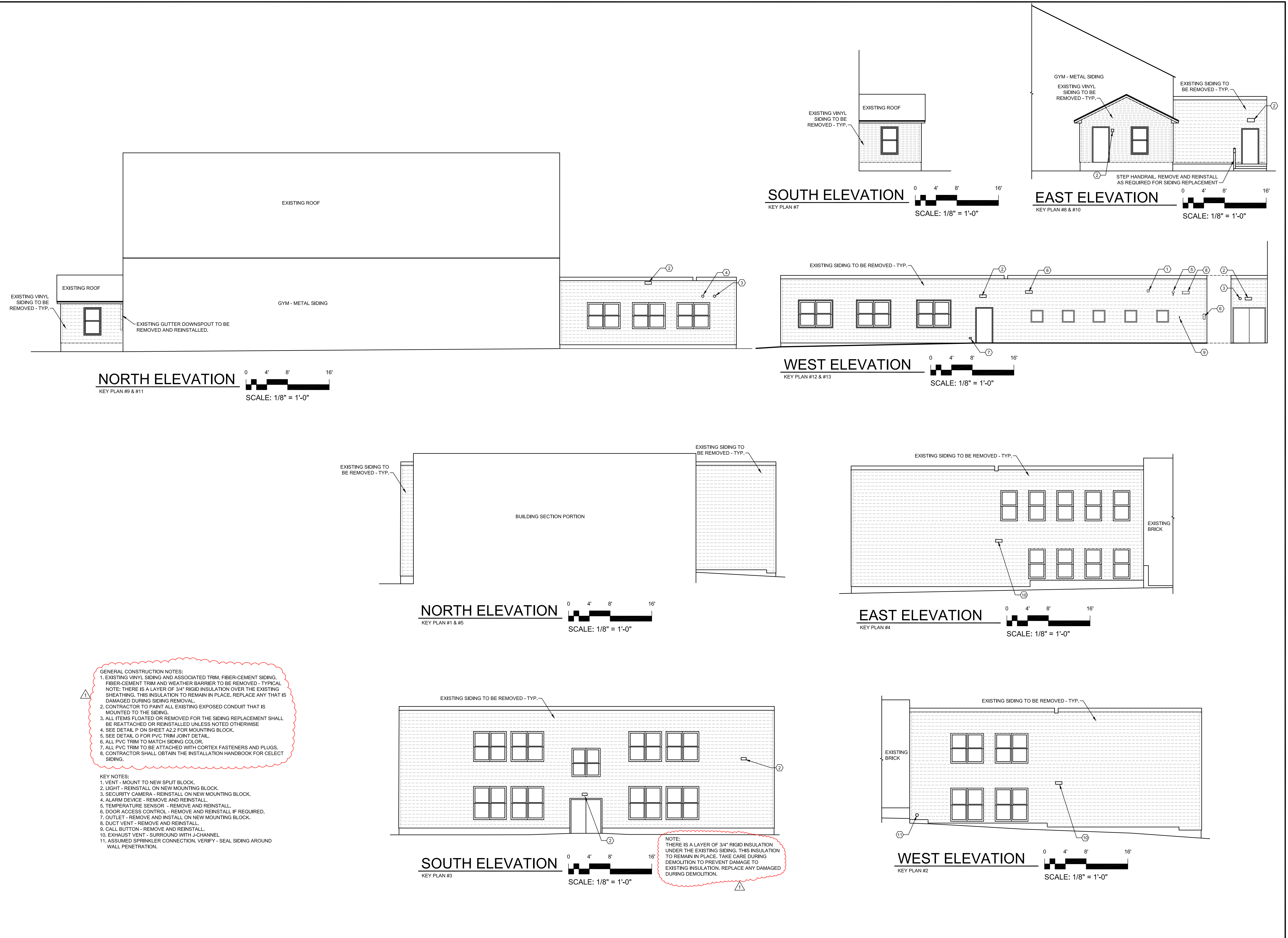

Project:  
**BELGRADE CENTRAL SCHOOL  
SIDING REPLACEMENT  
PROJECT**

Owner:  
**REGIONAL SCHOOL  
UNIT NO. 18**

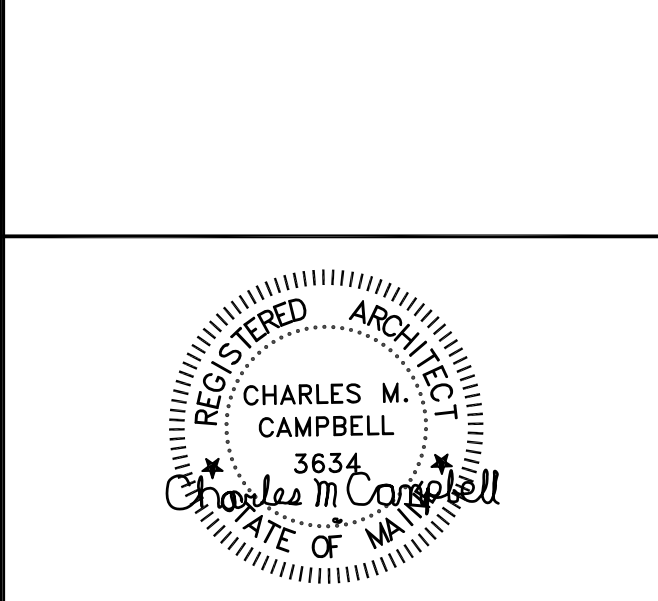

Consultant Name and Address:  
ARCHITECT  
**CHUCK CAMPBELL ARCHITECT PLLC**  
127 UNION ROAD  
WALDOBORO, MAINE 04572  
PHONE: (207) 557-0448  
E-MAIL: chuck@chuckcampbellarchitect.com  
WEBSITE: www.chuckcampbellarchitect.com

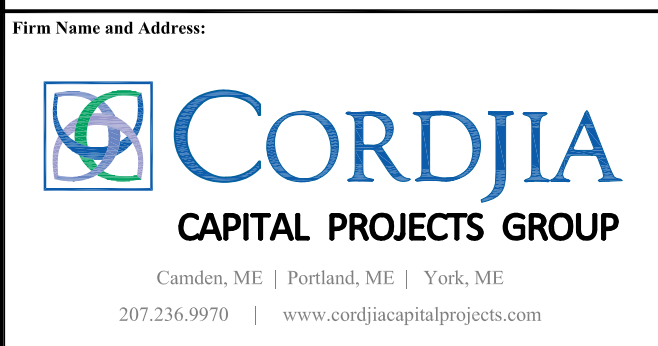

Sheet Title:  
**REMOVALS ELEVATIONS**

No.	Revision/Issue	Date
1	ADDENDUM #1	09/30/22

Design by:	CMC	Checked by:	MAD
Drawn by:	CMC	Approved by:	MAD
Project:	No. 1401	Date:	JUNE 24, 2022

Sheet:  
**AR1.1**

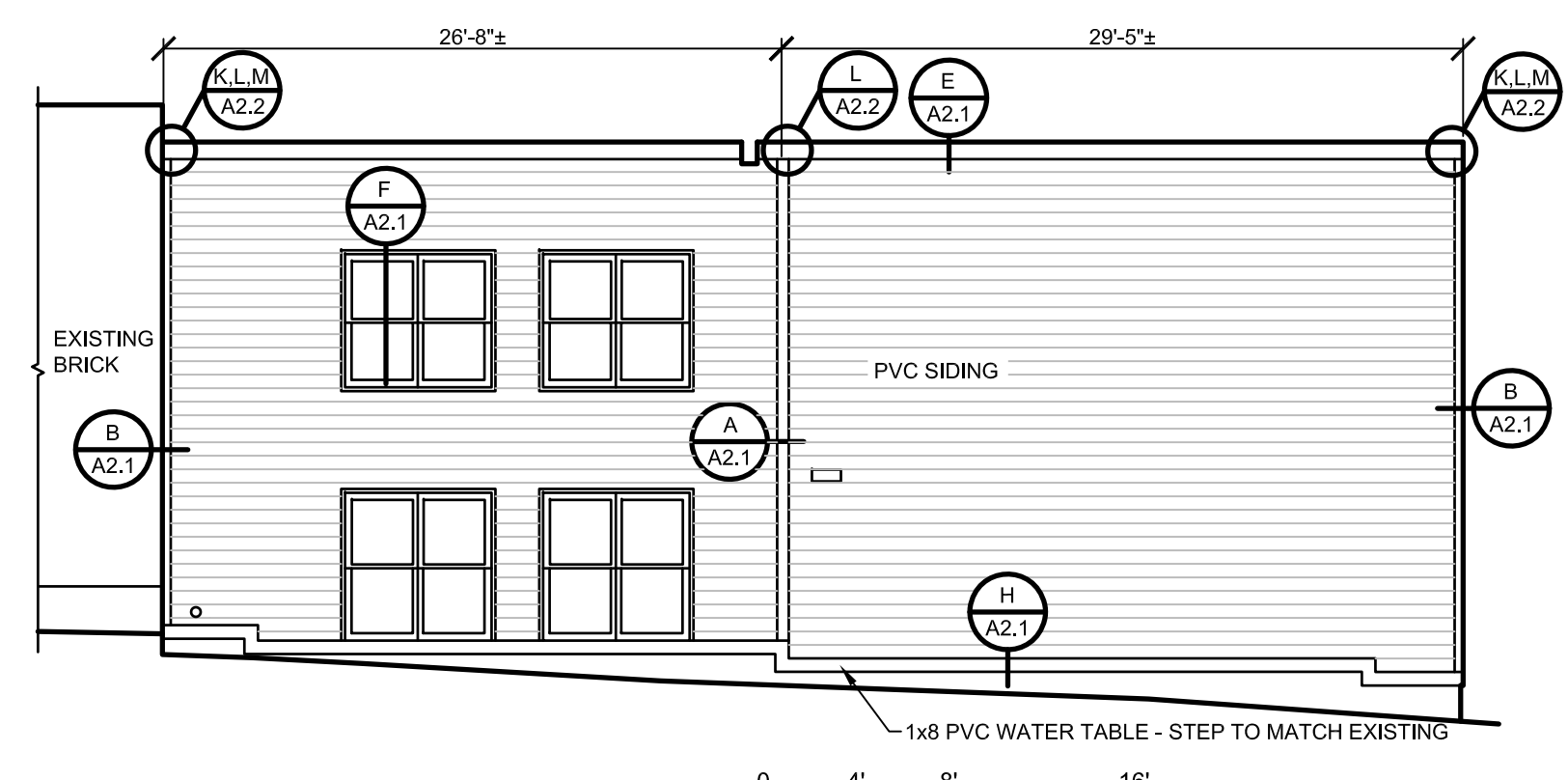
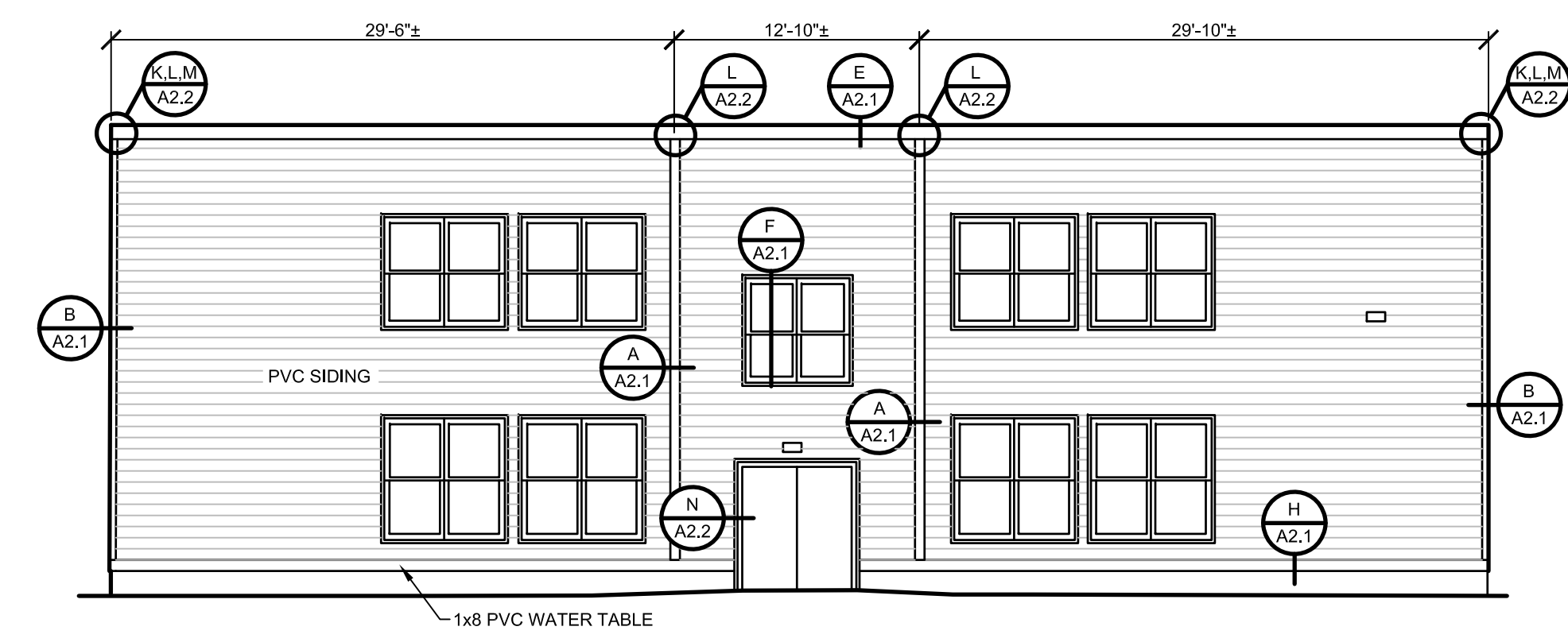
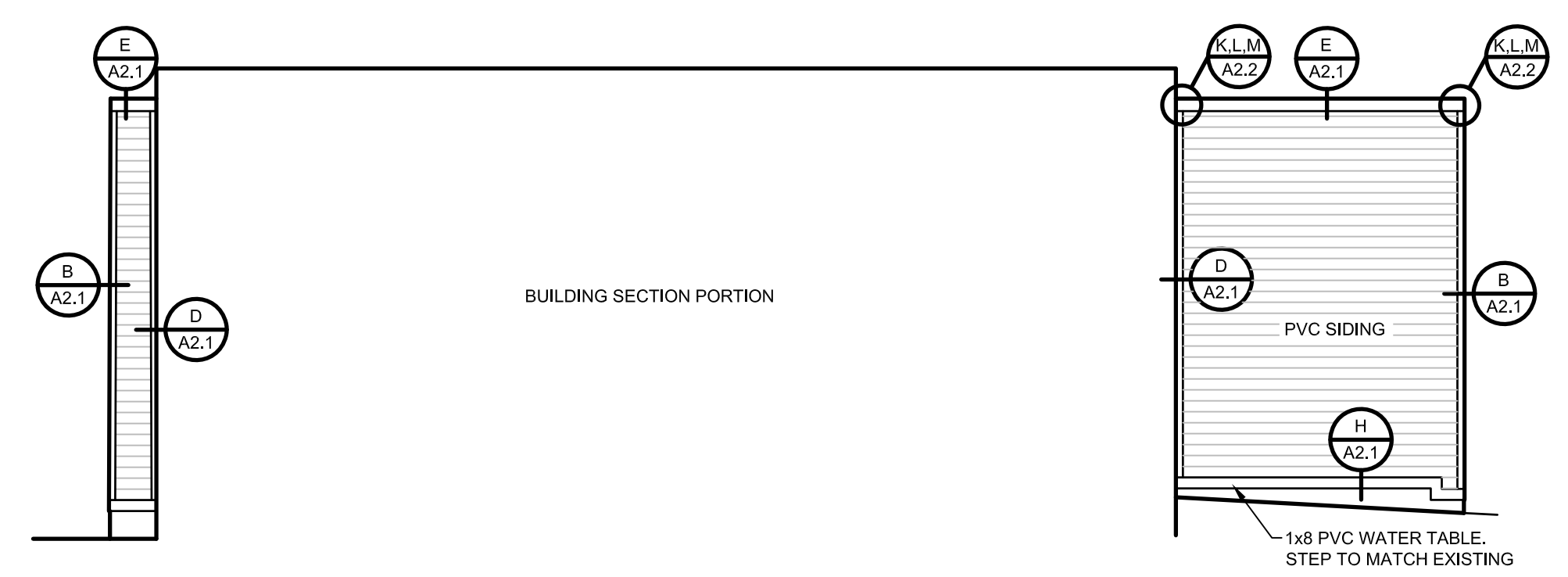
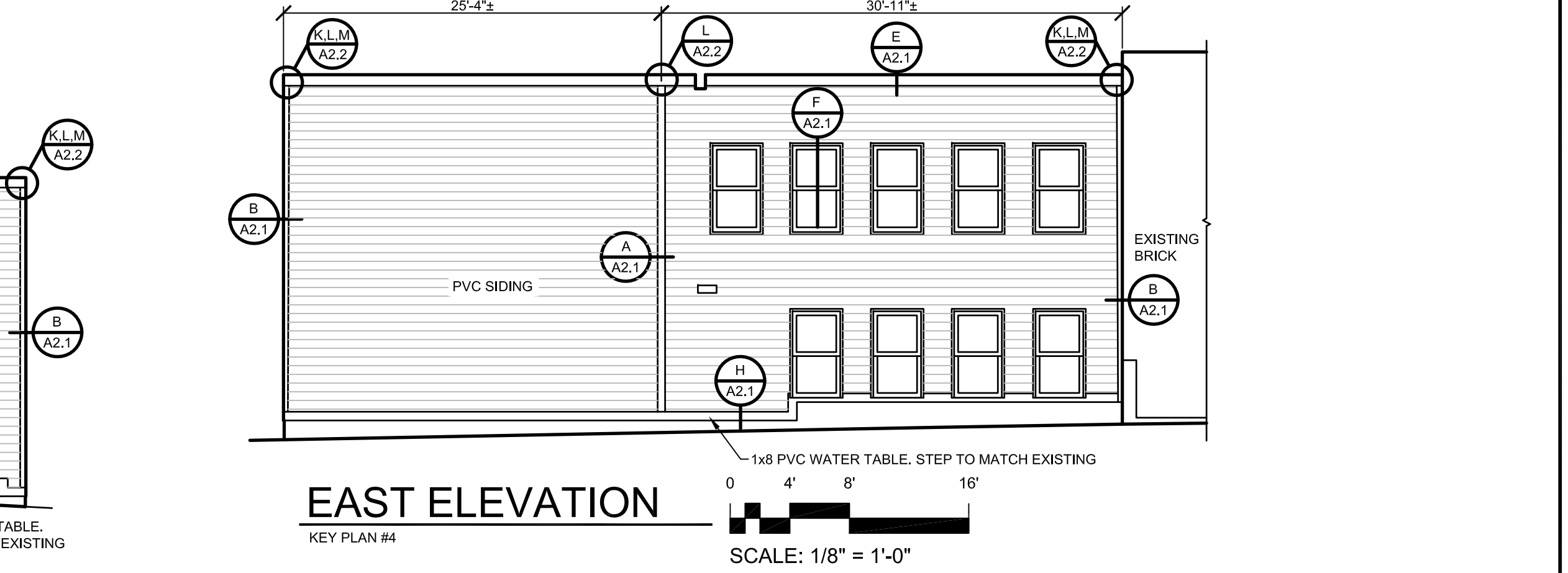
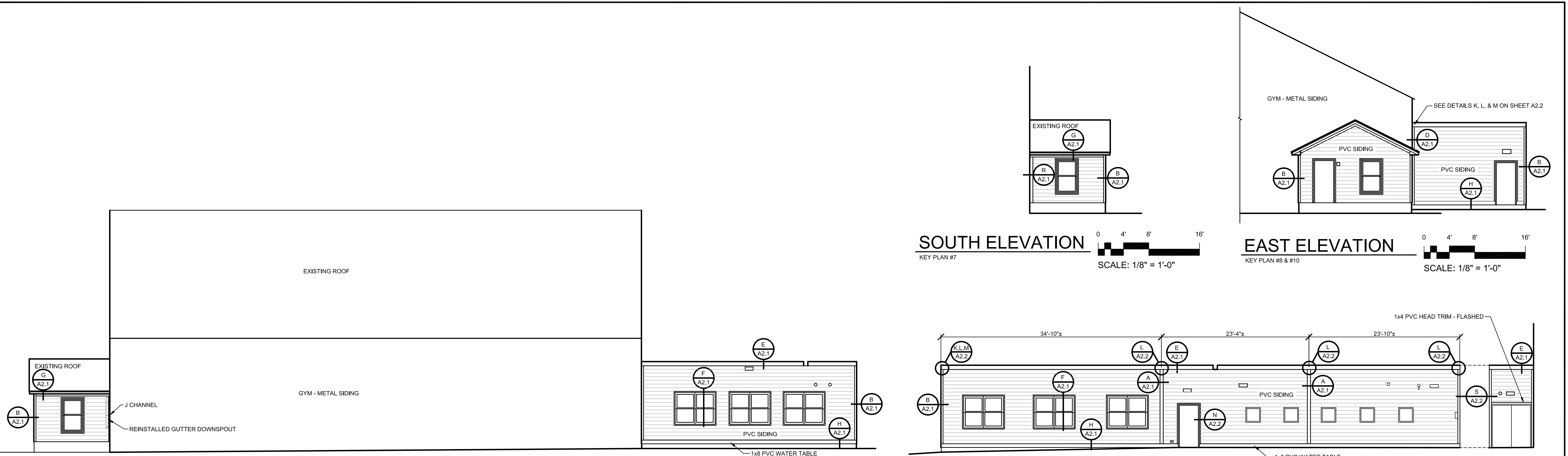

- GENERAL CONSTRUCTION NOTES:**
1. EXISTING VINYL SIDING AND ASSOCIATED TRIM, FIBER-CEMENT SIDING, FIBER-CEMENT TRIM AND WEATHER BARRIER TO BE REMOVED - TYPICAL NOTE: THERE IS A LAYER OF 3/4" RIGID INSULATION OVER THE EXISTING SHEATHING. THIS INSULATION TO REMAIN IN PLACE. REPLACE ANY THAT IS DAMAGED DURING SIDING REMOVAL.
  2. CONTRACTOR TO PAINT ALL EXISTING EXPOSED CONDUIT THAT IS MOUNTED TO THE SIDING.
  3. ALL ITEMS FLOATED OR REMOVED FOR THE SIDING REPLACEMENT SHALL BE REATTACHED OR REINSTALLED UNLESS NOTED OTHERWISE
  4. SEE DETAIL P ON SHEET A2.2 FOR MOUNTING BLOCK.
  5. SEE DETAIL O FOR PVC TRIM JOINT DETAIL.
  6. ALL PVC TRIM TO MATCH SIDING COLOR.
  7. ALL PVC TRIM TO BE ATTACHED WITH CORTEX FASTENERS AND PLUGS.
  8. CONTRACTOR SHALL OBTAIN THE INSTALLATION HANDBOOK FOR CELECT SIDING.

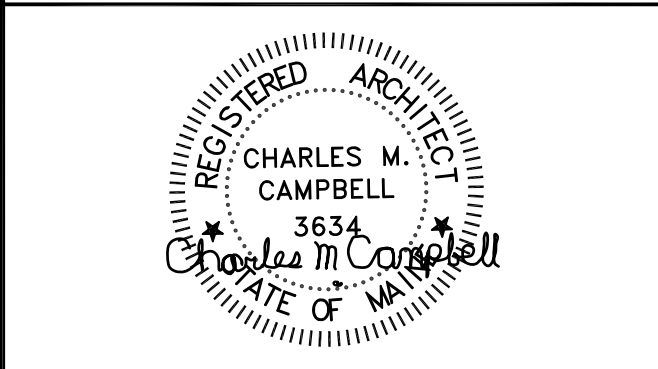

Consultant Name and Address:  
 ARCHITECT  
**CHUCK CAMPBELL ARCHITECT PLLC**  
 127 UNION ROAD  
 WALDOBORO, MAINE 04572  
 PHONE: (207) 557-0448  
 E-MAIL: chuck@chuckcampbellarchitect.com  
 WEBSITE: www.chuckcampbellarchitect.com

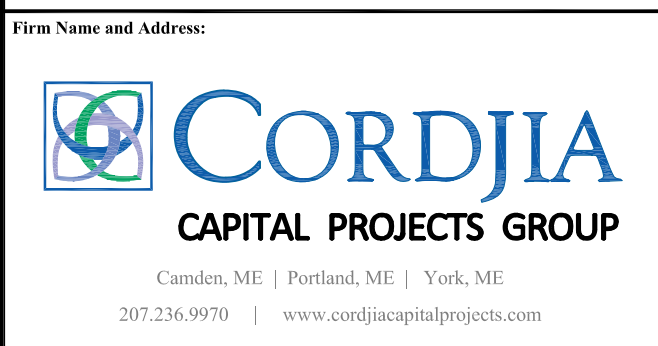

Sheet Title:  
**PROPOSED ELEVATIONS**

No.	Revision/Issue	Date
1	ADDENDUM #1	09/30/22

Design by:	CMC	Checked by:	MAD
Drawn by:	CMC	Approved by:	MAD
Project:	No. 1401	Date:	JUNE 24, 2022

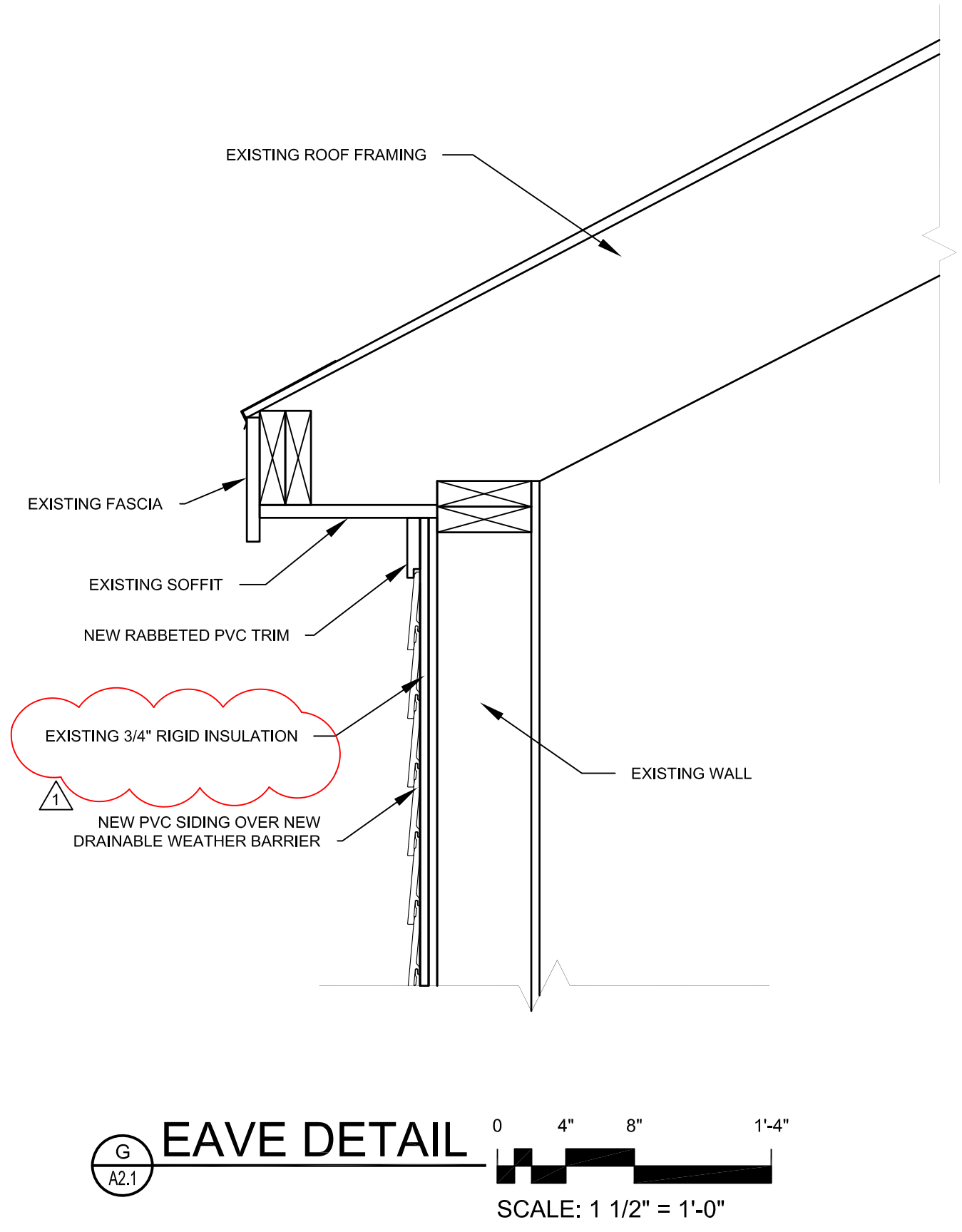
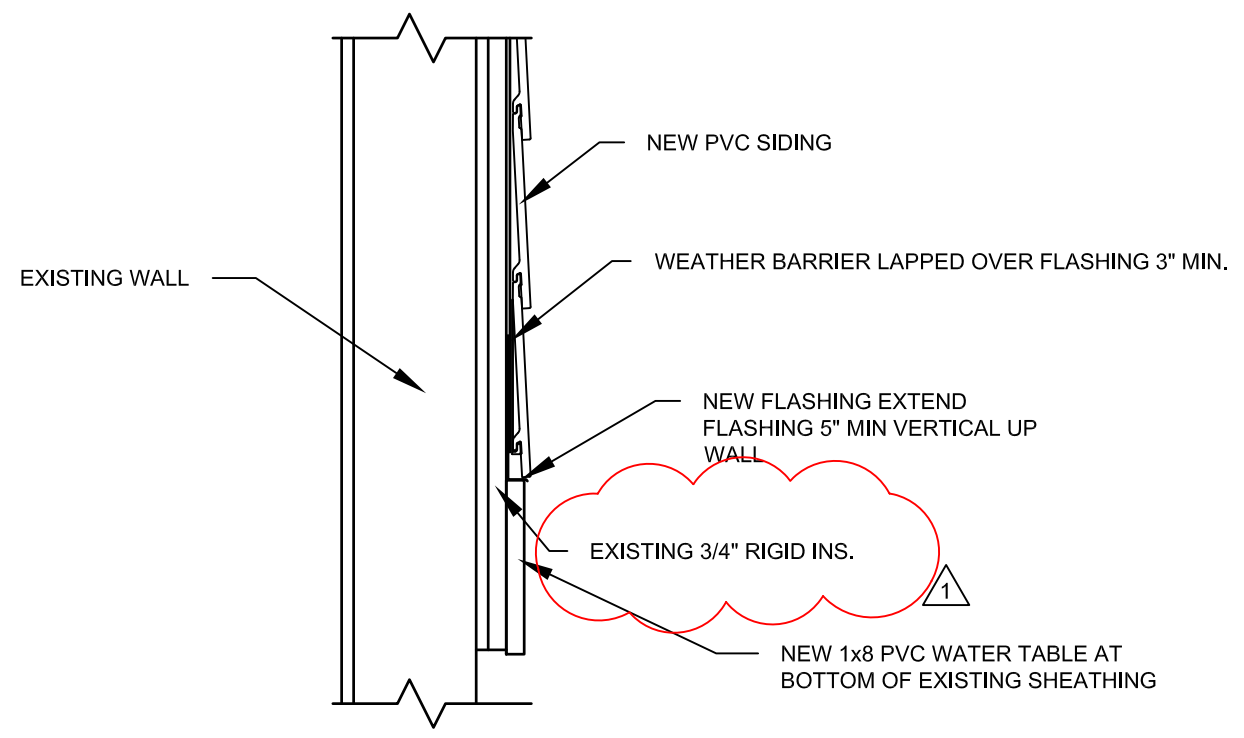
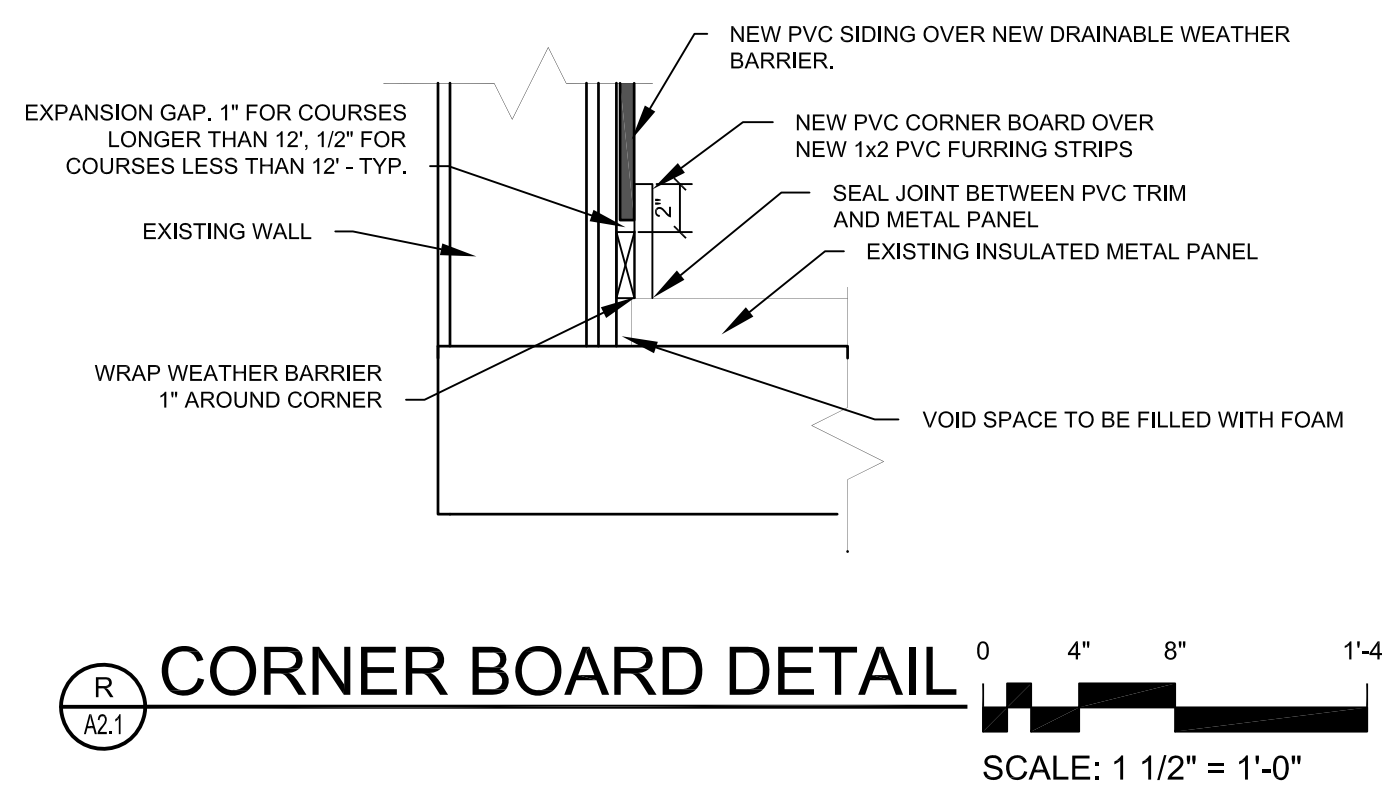

**WATER TABLE**  
SCALE: 1 1/2" = 1'-0"

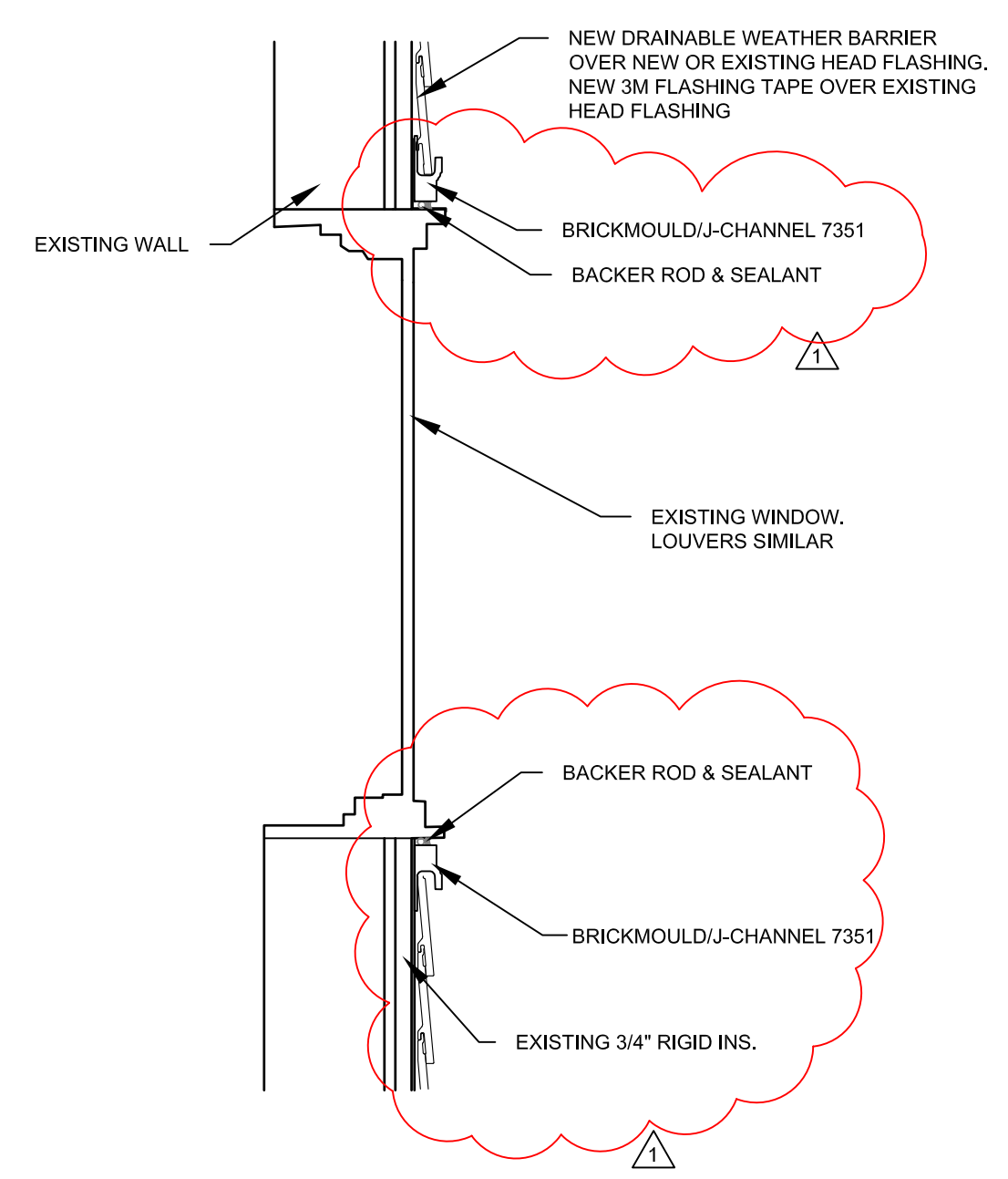

**OPENING TRIM DETAIL**  
SCALE: 1 1/2" = 1'-0"

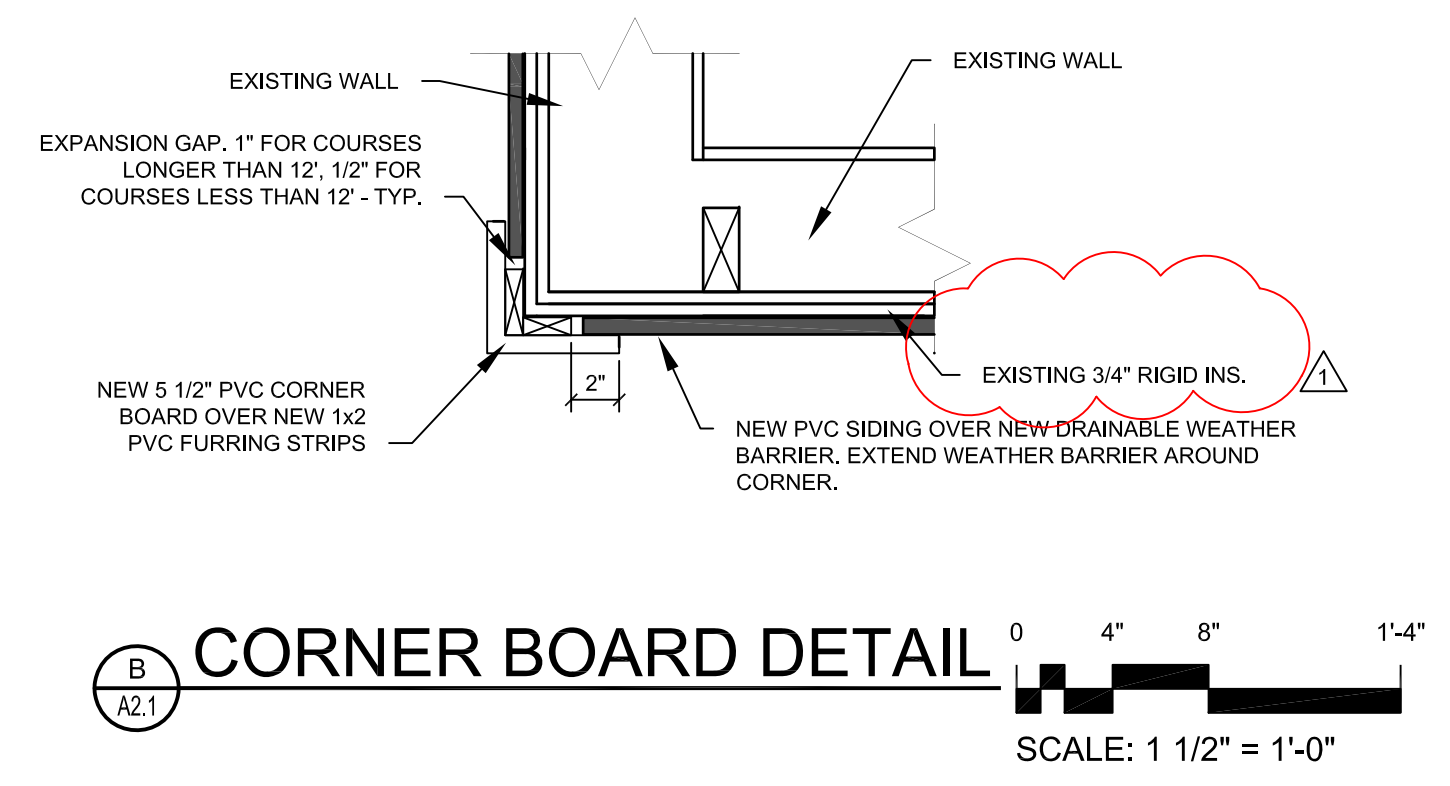

**CORNER BOARD DETAIL**  
SCALE: 1 1/2" = 1'-0"

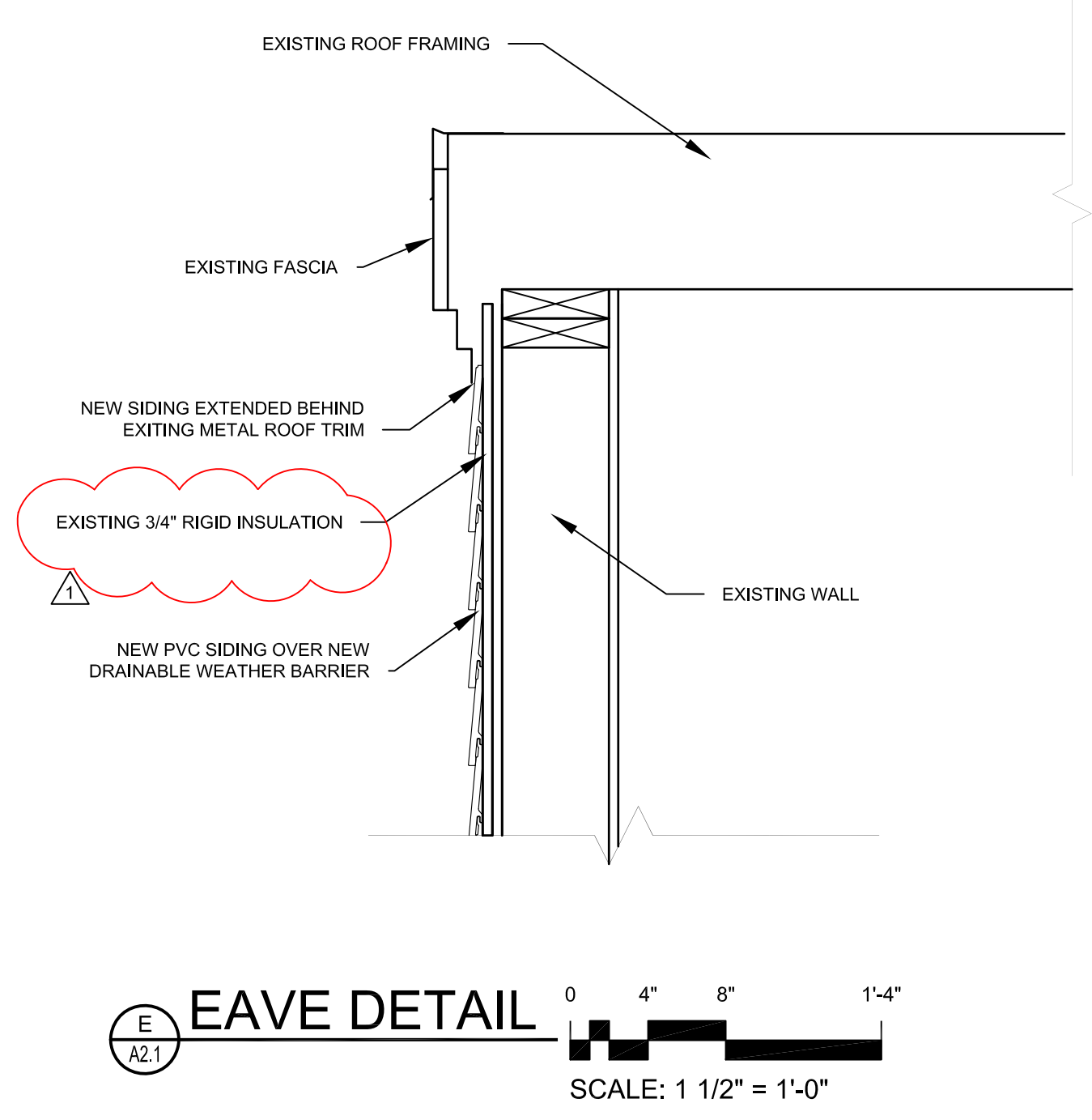

**EAVE DETAIL**  
SCALE: 1 1/2" = 1'-0"

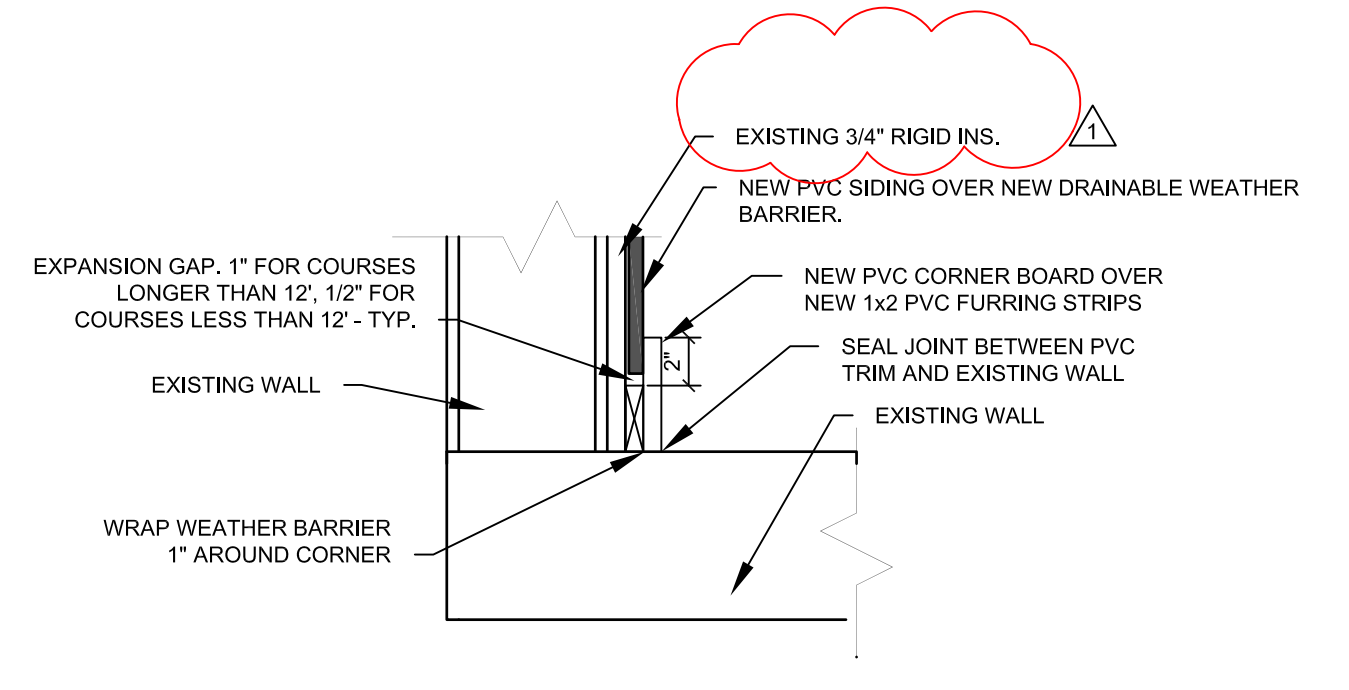

**CORNER BOARD DETAIL**  
SCALE: 1 1/2" = 1'-0"

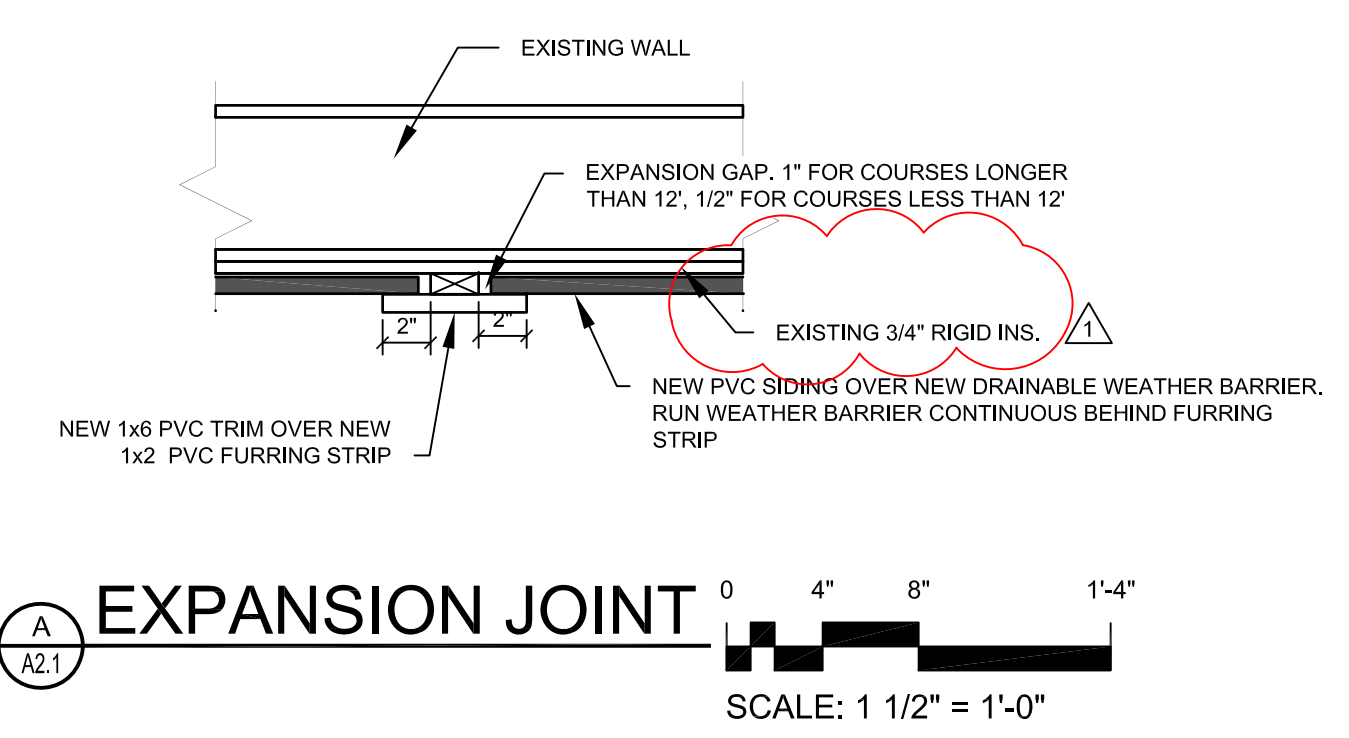

**EXPANSION JOINT**  
SCALE: 1 1/2" = 1'-0"

Project:  
**BELGRADE CENTRAL SCHOOL SIDING REPLACEMENT PROJECT**

Owner:  
**REGIONAL SCHOOL UNIT NO. 18**

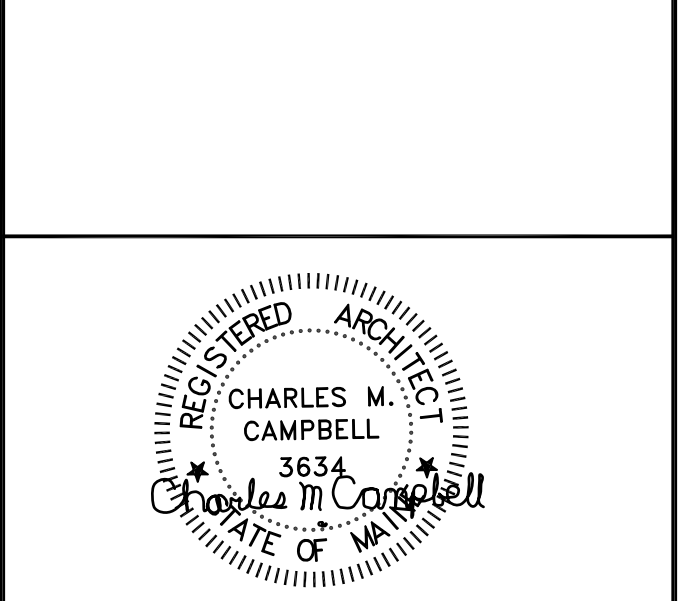
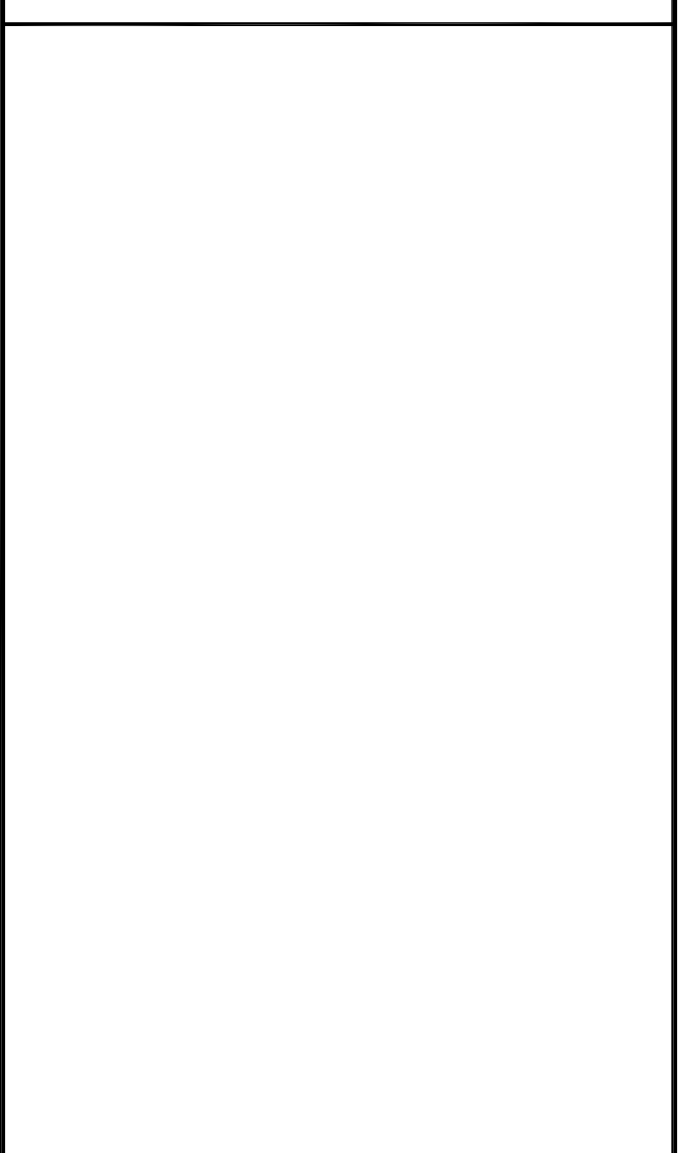

Consultant Name and Address:  
ARCHITECT  
**CHUCK CAMPBELL ARCHITECT PLLC**  
127 UNION ROAD  
WALDOBORO, MAINE 04572  
PHONE: (207) 557-0448  
E-MAIL: chuck@chuckcampbellarchitect.com  
WEBSITE: www.chuckcampbellarchitect.com

Firm Name and Address:  
**CORDJIA CAPITAL PROJECTS GROUP**  
Camden, ME | Portland, ME | York, ME  
207.236.9970 | www.cordjiacapitalprojects.com

Sheet Title:  
**DETAILS**

1	ADDENDUM #1	09/30/22
No.	Revision/Issue	Date
Design by:	CMC	Checked by: MAD
Drawn by:	CMC	Approved by: MAD
Project:	No. 1401	Date: JUNE 24, 2022

Sheet:  
**A2.1**

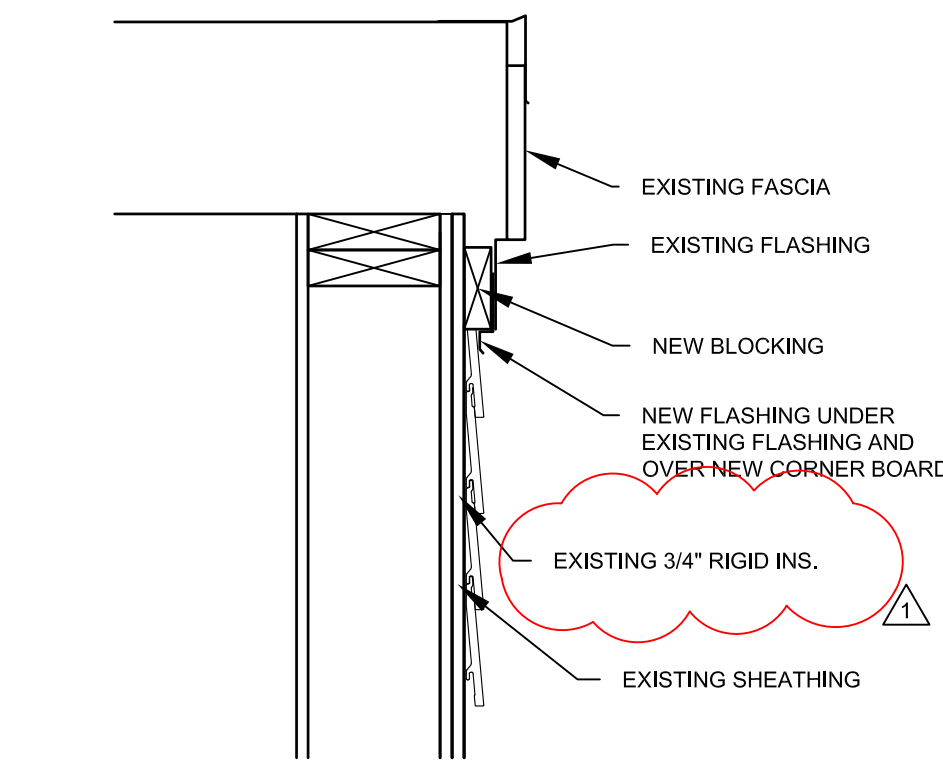

**M FLASHING**  
 NEW CORNER BOARD IS  
 NARROWER THAN EXISTING  
 CORNER BOARD FLASHING  
 SCALE: 1 1/2" = 1'-0"

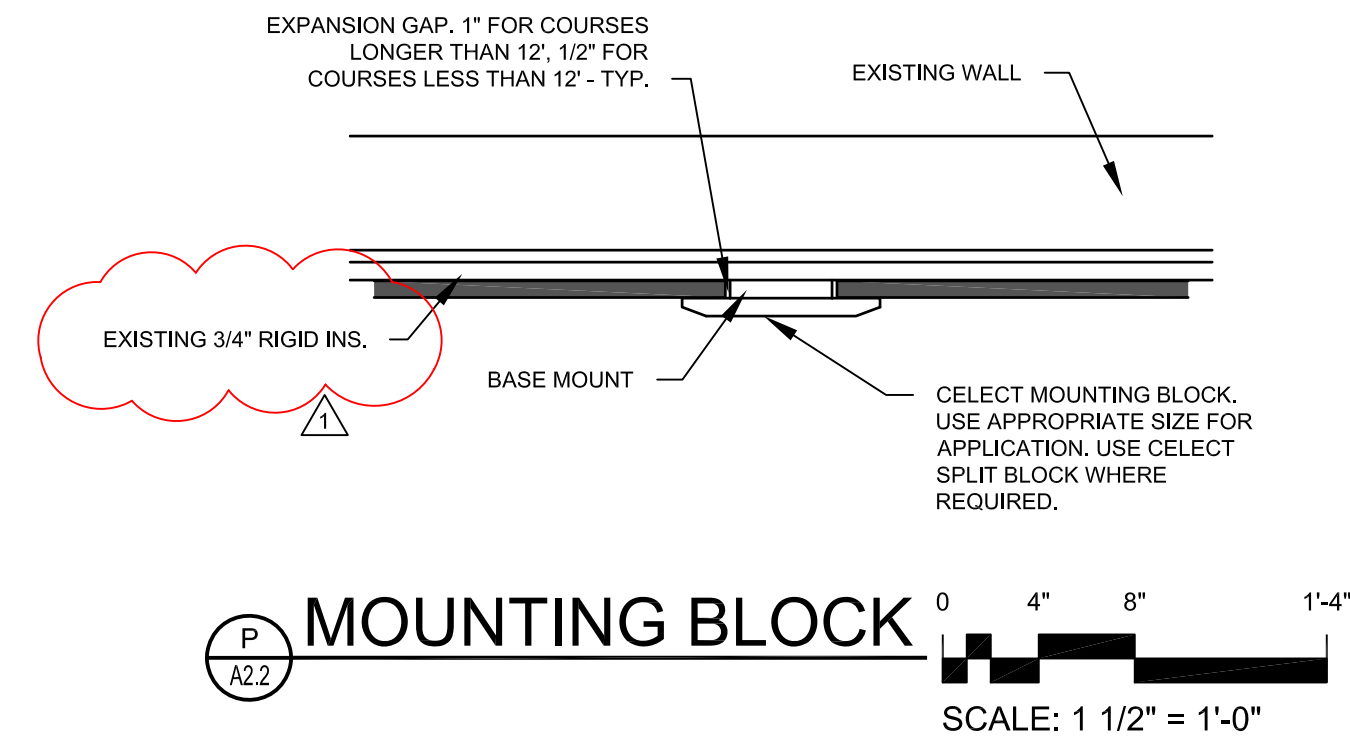

**P MOUNTING BLOCK**  
 SCALE: 1 1/2" = 1'-0"

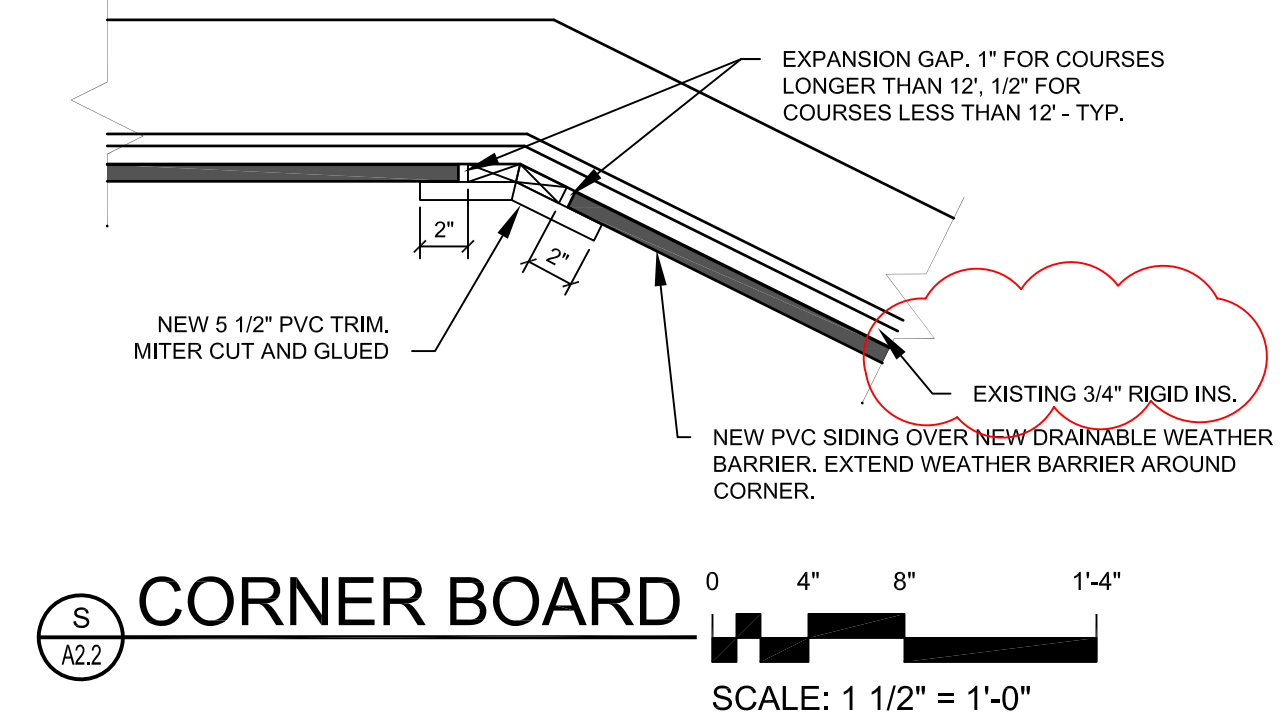

**S CORNER BOARD**  
 SCALE: 1 1/2" = 1'-0"

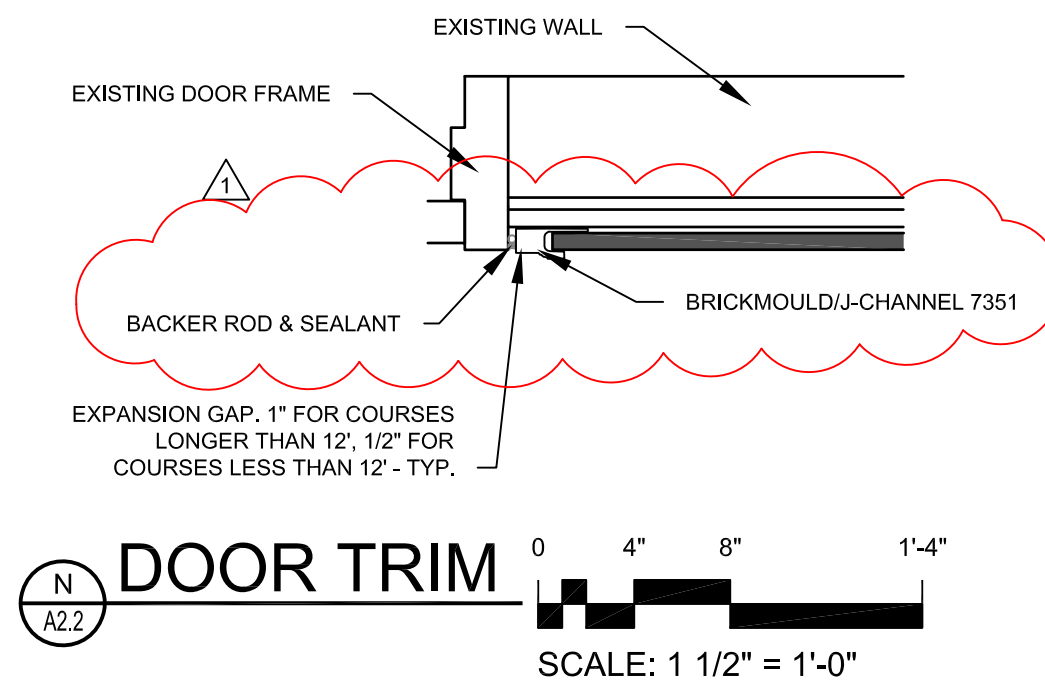

**N DOOR TRIM**  
 SCALE: 1 1/2" = 1'-0"

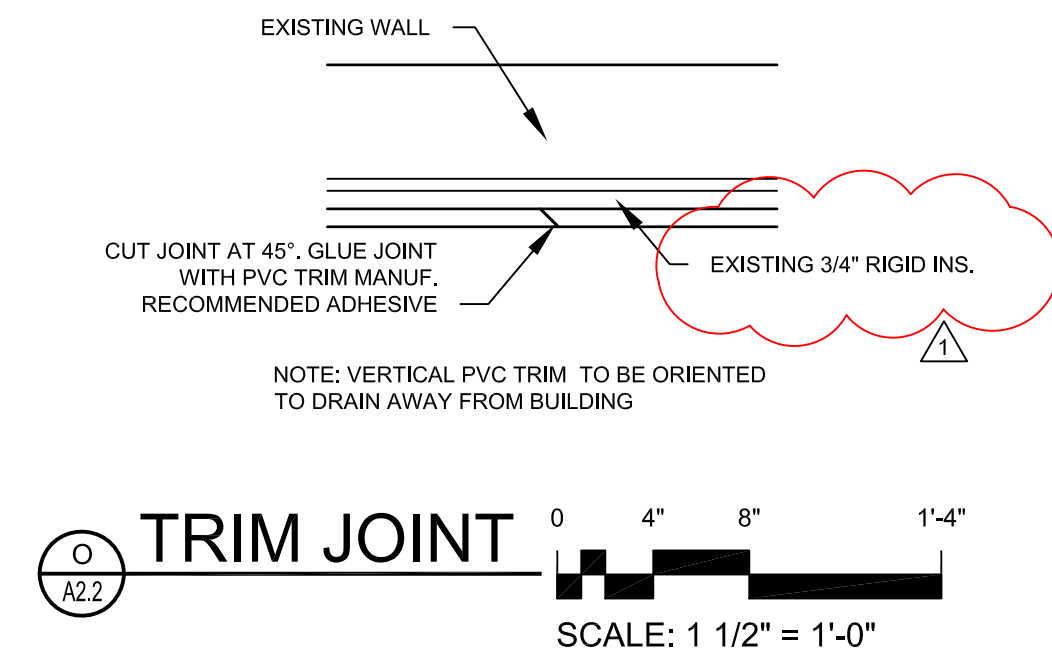

**O TRIM JOINT**  
 SCALE: 1 1/2" = 1'-0"

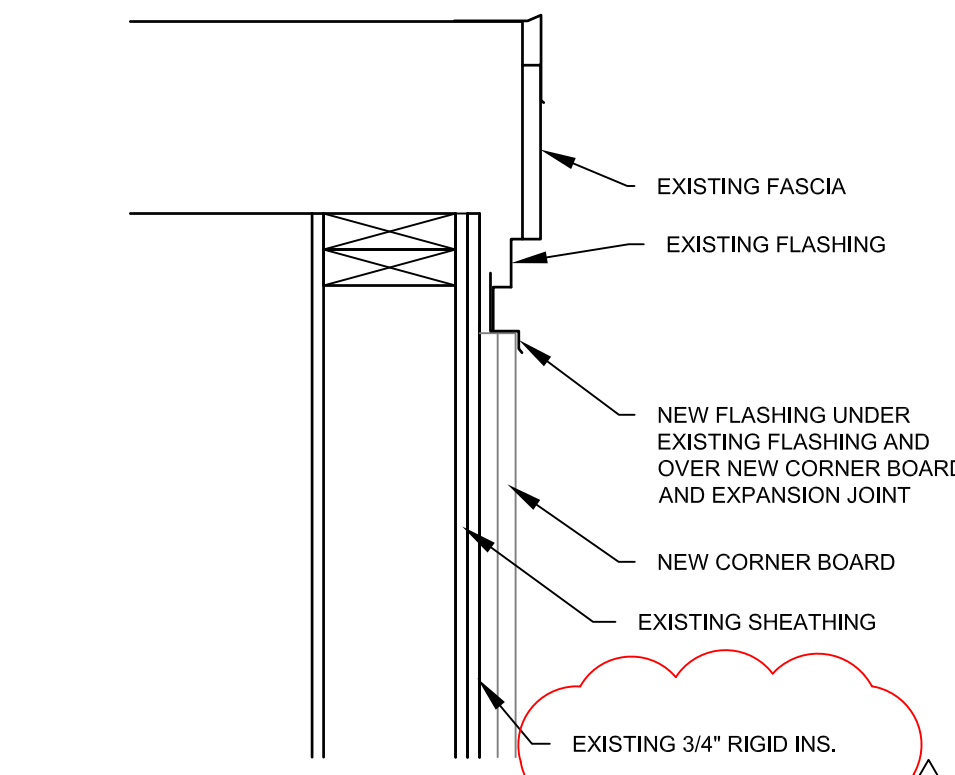

**L FLASHING**  
 NEW CORNER BOARD IS  
 WIDER THAN EXISTING CORNER BOARD  
 FLASHING AND NEW EXPANSION  
 JOINTS  
 SCALE: 1 1/2" = 1'-0"

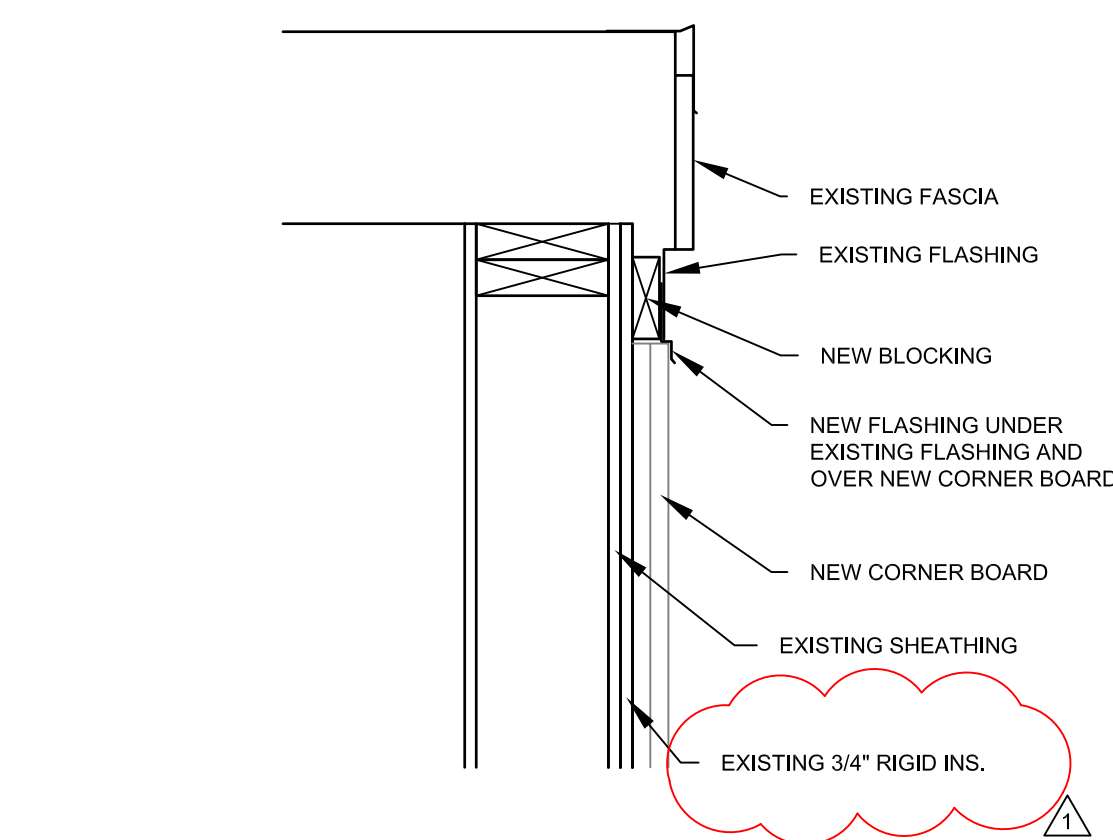

**K FLASHING**  
 CORNER BOARD ABUTTING  
 EXISTING CORNER BOARD  
 FLASHING  
 SCALE: 1 1/2" = 1'-0"



**CORNER BOARD** N.T.S.  
 SEE KEY PLAN FOR PHOTO LOCATION

Project:  
**BELGRADE CENTRAL  
 SCHOOL  
 SIDING REPLACEMENT  
 PROJECT**

Owner:  
**REGIONAL SCHOOL  
 UNIT NO. 18**

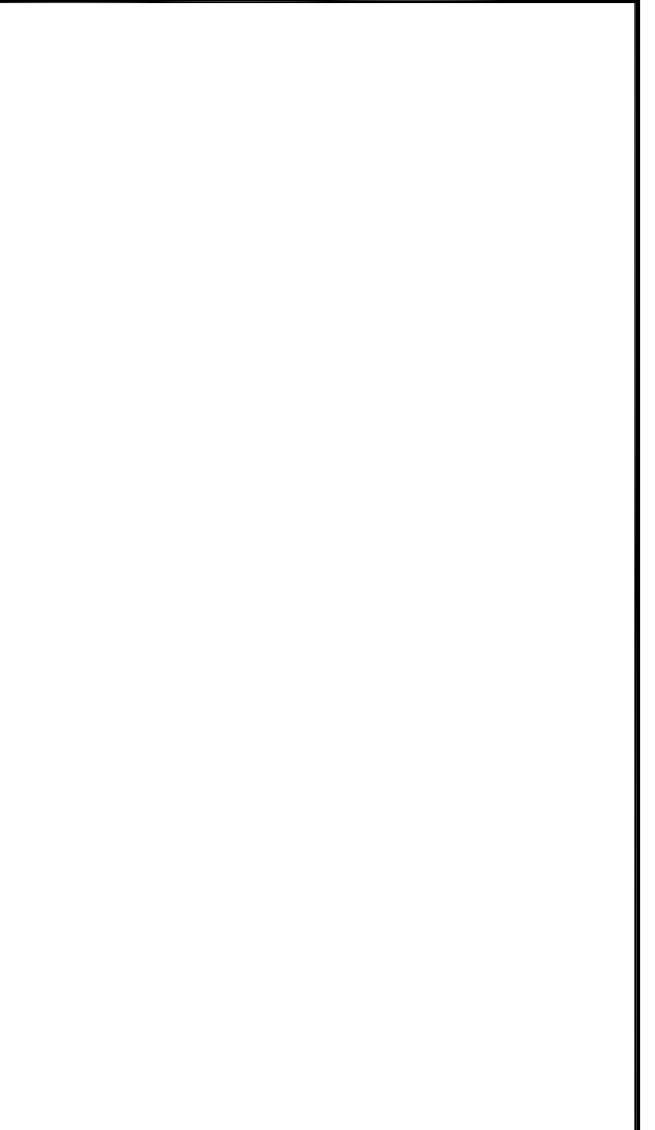

Consultant Name and Address:  
 ARCHITECT  
**CHUCK CAMPBELL ARCHITECT PLLC**  
 127 UNION ROAD  
 WALDOBORO, MAINE 04572  
 PHONE: (207) 557-0448  
 E-MAIL: chuck@chuckcampbellarchitect.com  
 WEBSITE: www.chuckcampbellarchitect.com

Firm Name and Address:  
  
**CORDJIA**  
 CAPITAL PROJECTS GROUP  
 Camden, ME | Portland, ME | York, ME  
 207.236.9970 | www.cordjiacapitalprojects.com

Sheet Title:  
**DETAILS**

No.	Revision/Issue	Date
1	ADDENDUM #1	09/30/22
Design by:	CMC	Checked by: MAD
Drawn by:	CMC	Approved by: MAD
Project:	No. 1401	Date: JUNE 24, 2022

Sheet:  
**A2.2**